





A-S500/A-S300

Integrated Amplifier

OWNER'S MANUAL

CAUTION: READ THIS BEFORE OPERATING YOUR UNIT.

- To assure the finest performance, please read this manual carefully. Keep it in a safe place for future reference.
- Install this sound system in a well ventilated, cool, dry, clean place - away from direct sunlight, heat sources, vibration, dust, moisture, and/or cold. For proper ventilation, allow the following minimum clearances around this unit.
Top: 30 cm (11-3/4 in)
Rear: 20 cm (7-7/8 in)
Sides: 20 cm (7-7/8 in)
- Locate this unit away from other electrical appliances, motors, or transformers to avoid humming sounds.
- Do not expose this unit to sudden temperature changes from cold to hot, and do not locate this unit in an environment with high humidity (i.e. a room with a humidifier) to prevent condensation inside this unit, which may cause an electrical shock, fire, damage to this unit, and/or personal injury.
- Avoid installing this unit where foreign object may fall onto this unit and/or this unit may be exposed to liquid dripping or splashing. On the top of this unit, do not place:
 - Other components, as they may cause damage and/or discoloration on the surface of this unit.
 - Burning objects (i.e. candles), as they may cause fire, damage to this unit, and/or personal injury.
 - Containers with liquid in them, as they may fall and liquid may cause electrical shock to the user and/or damage to this unit.
- Do not cover this unit with a newspaper, tablecloth, curtain, etc. in order not to obstruct heat radiation. If the temperature inside this unit rises, it may cause fire, damage to this unit, and/or personal injury.
- Do not plug in this unit to a wall outlet until all connections are complete.
- Do not operate this unit upside-down. It may overheat, possibly causing damage.
- Do not use force on switches, knobs and/or cords.
- When disconnecting the power cable from the wall outlet, grasp the plug; do not pull the cable.
- Do not clean this unit with chemical solvents; this might damage the finish. Use a clean, dry cloth.
- Only voltage specified on this unit must be used. Using this unit with a higher voltage than specified is dangerous and may cause fire, damage to this unit, and/or personal injury. Yamaha will not be held responsible for any damage resulting from use of this unit with a voltage other than specified.
- To prevent damage by lightning, keep the power cable and outdoor antennas disconnected from a wall outlet or this unit during a lightning storm.
- Do not attempt to modify or fix this unit. Contact qualified Yamaha service personnel when any service is needed. The cabinet should never be opened for any reasons.
- When not planning to use this unit for long periods of time (i.e. vacation), disconnect the AC power plug from the wall outlet.
- Be sure to read the "TROUBLESHOOTING" section on common operating errors before concluding that this unit is faulty.
- Before moving this unit, press  to turn off this unit, and then disconnect the AC power plug from the wall outlet.
- Condensation will form when the surrounding temperature changes suddenly. Disconnect the power cable from the outlet, then leave this unit alone.
- When using this unit for a long time, this unit may become warm. Turn the power off, then leave this unit alone for cooling.
- Install this unit near the AC outlet and where the AC power plug can be reached easily.
- The batteries shall not be exposed to excessive heat such as sunshine, fire or the like. When you dispose of batteries, follow your regional regulations.
- Excessive sound pressure from earphones and headphones can cause hearing loss.

As long as this unit is connected to the AC wall outlet, it is not disconnected from the AC power source even if you turn off this unit by  or set it to the standby mode by  button on the remote control. In this state, this unit is designed to consume a very small quantity of power.

WARNING

TO REDUCE THE RISK OF FIRE OR ELECTRIC SHOCK, DO NOT EXPOSE THIS UNIT TO RAIN OR MOISTURE.

A-S500 only



This label is required to be attached to a product of which the temperature of the top cover may be hot during operation.

For U.K. customers

If the socket outlets in the home are not suitable for the plug supplied with this appliance, it should be cut off and an appropriate 3 pin plug fitted. For details, refer to the instructions described below.

Note

The plug severed from the mains lead must be destroyed, as a plug with bared flexible cord is hazardous if engaged in a live socket outlet.

Special Instructions for U.K. Model

IMPORTANT

THE WIRES IN MAINS LEAD ARE COLOURED IN ACCORDANCE WITH THE FOLLOWING CODE:

Blue: NEUTRAL
Brown: LIVE

As the colours of the wires in the mains lead of this apparatus may not correspond with the coloured markings identifying the terminals in your plug, proceed as follows:

The wire which is coloured BLUE must be connected to the terminal which is marked with the letter N or coloured BLACK.

The wire which is coloured BROWN must be connected to the terminal which is marked with the letter L or coloured RED.

Make sure that neither core is connected to the earth terminal of the three pin plug.

CONTENTS

INTRODUCTION

USEFUL FEATURES	1
SUPPLIED ACCESSORIES	1
CONTROLS AND FUNCTIONS	2
Front panel and Remote control	2
About the remote control	3
Rear panel	4

PREPARATION

CONNECTIONS	5
Connecting speakers and source components.....	5
Connecting the power cable.....	7

OPERATION

PLAYING AND RECORDING	8
Playing a source	8
Adjusting the tonal quality	8
Recording a source	9
PLAYING BACK TUNES FROM YOUR iPhone/iPod	10
Using a Universal Dock for iPod.....	11
Using a Wireless System for iPod	12

ADDITIONAL INFORMATION

TROUBLESHOOTING	13
SPECIFICATIONS	17

INTRODUCTION

PREPARATION

OPERATION

ADDITIONAL
INFORMATION

■ About this manual

- ☼ indicates a tip for your operation.
- Some operations can be performed by using either the buttons on the main unit or on the remote control. In cases when the button names differ between the main unit and the remote control, the names of the buttons on the remote control are given in parentheses.
- This manual is printed prior to production. Design and specifications are subject to change in part as a result of improvements, etc. In case of differences between the manual and the product, the product has priority.

USEFUL FEATURES

This unit allows you to:

- ◆ Improve sound quality by using the Pure Direct (p. 8) function
- ◆ Play back music from your iPhone/iPod (optional Yamaha product required; p. 10)
- ◆ Select the recording source independently of the listening source (A-S500 only; p. 9)
- ◆ Control other Yamaha components using this unit's remote control (p. 3)
- ◆ Boost bass sounds by connecting a subwoofer (p. 5)
- ◆ Save power by using POWER MANAGEMENT switch (p. 7)

SUPPLIED ACCESSORIES

Please check that you received all of the following parts:

Remote control



Batteries (x 2) (AA, R6, UM-3)

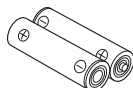

CONTROLS AND FUNCTIONS

Front panel and Remote control

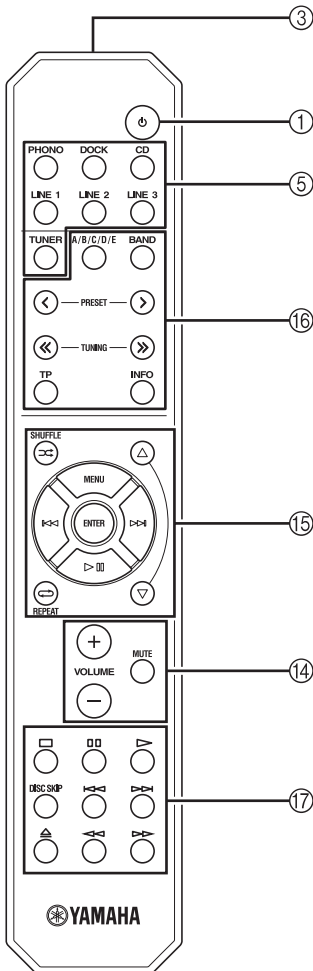
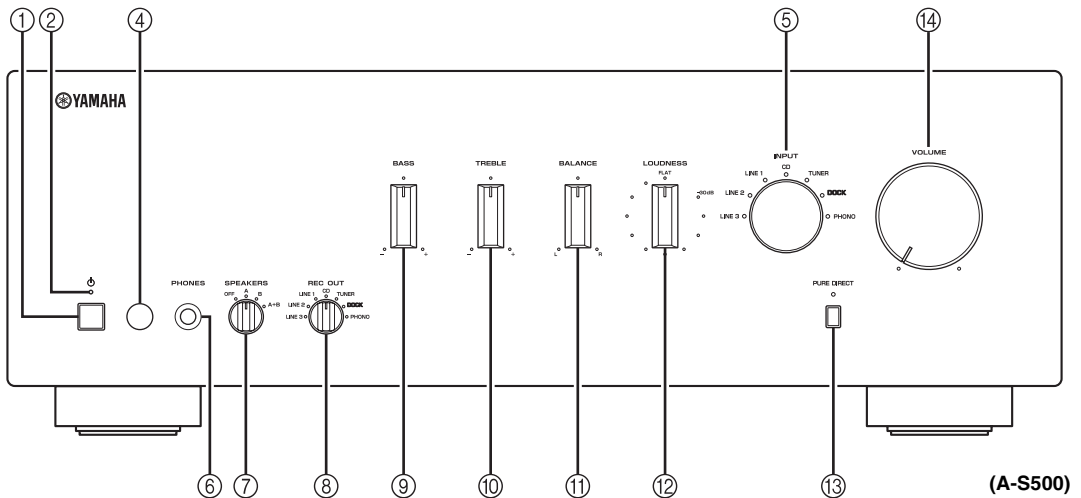

① **⏻ (POWER)**

Front panel: ⏻ switch

Turns on and off the power of this unit.

On position: Pushed inward

Off position: Released outward

Remote control: ⏻ button

When this unit is turned on: turns this unit on or sets it to standby mode.

Note

This unit consumes a small amount of power even when turned off or when in standby mode.

② **POWER on indicator**

Lights up as follows:

Brightly lit: Power is on

Dimly lit: Standby mode

Off: Power is off



The POWER on indicator remains brightly lit while an iPhone/iPod is being charged, even if this unit is in standby mode.

③ **Infrared signal transmitter**

Sends signals to the main unit.

④ **Remote control sensor**

Receives signals from the remote control.

⑤ **INPUT selector and indicators**

Select the input source you want to listen to. The input source indicators light up when the corresponding input sources are selected.



The input source names correspond to the names of the connection jacks on the rear panel.

⑥ **PHONES jack**

Connect headphones for private listening. If you do not want sound to be heard from the speakers, set the SPEAKERS selector to OFF.

⑦ **SPEAKERS selector**

Turn on or off the speaker set connected to the SPEAKERS A and/or B terminals on the rear panel each time the corresponding SPEAKERS selector is set to A, B or A+B.

⑧ **REC OUT selector (A-S500 only)**

Select a source for recording independently of the INPUT selector setting, allowing you to record the selected source while listening to another source (see page 9).

⑨ **BASS control**

Increases or decreases the low frequency response (see page 9).

⑩ **TREBLE control**

Increases or decreases the high frequency response (see page 9).

⑪ **BALANCE control**

Adjusts the sound output balance of the left and right speakers (see page 9).

⑫ **LOUDNESS control**

Retains a full tonal range at any volume level (see page 9).

⑬ **PURE DIRECT switch and indicator**

Reproduces any input source in the purest sound possible. The indicator above it lights up when this function is turned on (see page 8).

⑭ **VOLUME control**

VOLUME +/-

Control the sound output level.

This does not affect the REC level for recording.

MUTE button (Remote control only)

Decreases the current volume by about 20 dB.



- The INPUT indicator for the current input source blinks while the output is muted.
- The mute is released when MUTE button is pressed again, or when the volume is adjusted by rotating the VOLUME control on the front panel or by pressing the VOLUME +/- buttons on the remote control.

⑮ **iPhone/iPod control buttons**

Control an iPhone/iPod that is connected using an optional Yamaha Universal Dock for iPod (see page 11) or Wireless System for iPod (see page 12).

⑯ **Yamaha tuner control buttons**

Control various functions of a Yamaha tuner.

Note

Even when using a Yamaha tuner, certain components and features may not be available. Refer to your component's owner's manual for more information.

⑰ **Yamaha CD player control buttons**

Control various functions of a Yamaha CD player.

Note

Even when using a Yamaha CD player, certain components and features may not be available. Refer to your component's owner's manual for more information.

About the remote control

■ **Installing batteries in the remote control**

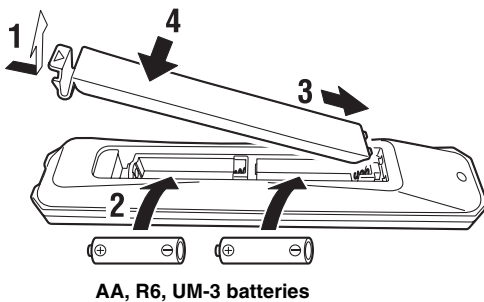

Note

Make sure that the polarities are correct. See the illustration inside the battery compartment.

■ **Using the remote control**

The remote control transmits a directional infrared beam. Be sure to aim the remote control directly at the remote control sensor on the front panel of this unit during operation.

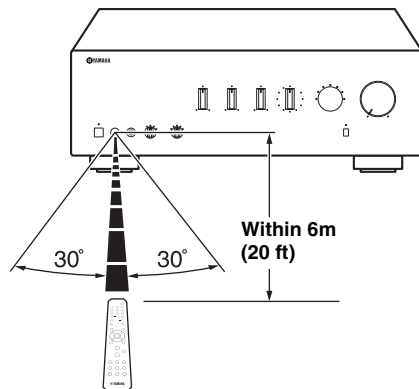

Note

The area between the remote control and this unit must be clear of large obstacles.

Rear panel

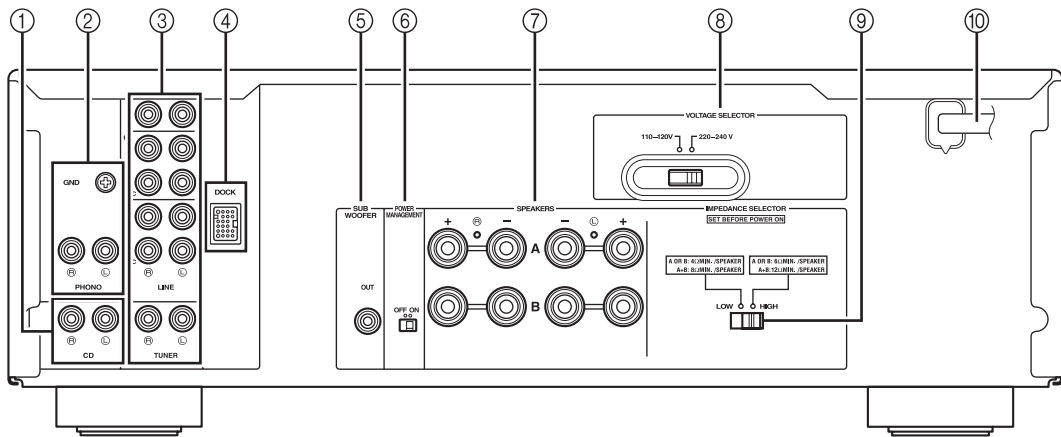

(Taiwan and Central/South America models)

① CD input jacks

Used to connect a CD player (see page 5).

② PHONO jacks and GND terminal

Used to connect a turntable that uses an MM cartridge, and to ground the terminal (see page 5).

③ Audio input/output jacks

Used to connect external components, such as a tuner, etc (see page 5).

④ DOCK jack

Used to connect an optional Yamaha Universal Dock for iPod or Wireless System for iPod (see page 10).

⑤ SUBWOOFER OUT jack

Used to connect a subwoofer with built-in amplifier (see page 5).



The SUBWOOFER OUT jack attenuates signals over 90 Hz.

⑥ POWER MANAGEMENT switch

Enables or disables the automatic power down function (see page 7).

⑦ SPEAKERS A/B terminals

Used to connect one or two speaker sets (see page 5).

⑧ VOLTAGE SELECTOR switch (Taiwan and Central/South America models only)

The VOLTAGE SELECTOR switch must be set to your local main voltage before plugging the power cable into the wall outlet (see page 7).

⑨ IMPEDANCE SELECTOR switch

See IMPEDANCE SELECTOR switch on this page.

⑩ Power cable

Connect the power cable into the wall outlet (see page 7).

■ IMPEDANCE SELECTOR switch

CAUTION

Do not change the IMPEDANCE SELECTOR switch while the power of this unit is turned on, as doing so may damage the unit.

If the unit fails to turn on, the IMPEDANCE SELECTOR switch may not be fully slid to either position. If this is the case, remove the power cable and slide the switch all the way to either position.

Select the switch position (LOW or HIGH) according to the impedance of the speakers in your system.

Switch position	Impedance level
HIGH	<ul style="list-style-type: none"> If you use one set (A or B), the impedance of each speaker must be 6 Ω or higher. If you use two sets (A and B) simultaneously, the impedance of each speaker must be 12 Ω or higher. If you make bi-wire connections, the impedance of each speaker must be 6 Ω or higher. See page 6 for details.
LOW	<ul style="list-style-type: none"> If you use one set (A or B), the impedance of each speaker must be 4 Ω or higher. If you use two sets (A and B) simultaneously, the impedance of each speaker must be 8 Ω or higher. If you make bi-wire connections, the impedance of each speaker must be 4 Ω or higher. See page 6 for details.

CONNECTIONS

Connecting speakers and source components

CAUTION

- Do not connect this unit or other components to the main power until all connections between components are complete.
- All connections must be correct: L (left) to L, R (right) to R, “+” to “+” and “-” to “-”. If the connections are faulty, no sound will be heard from the speakers, and if the polarity of the speaker connections is incorrect, the sound will be unnatural and lack bass. Refer to the owner’s manual for each of your components.
- Use RCA cables for audio components (except for speaker connections and DOCK jack connections).

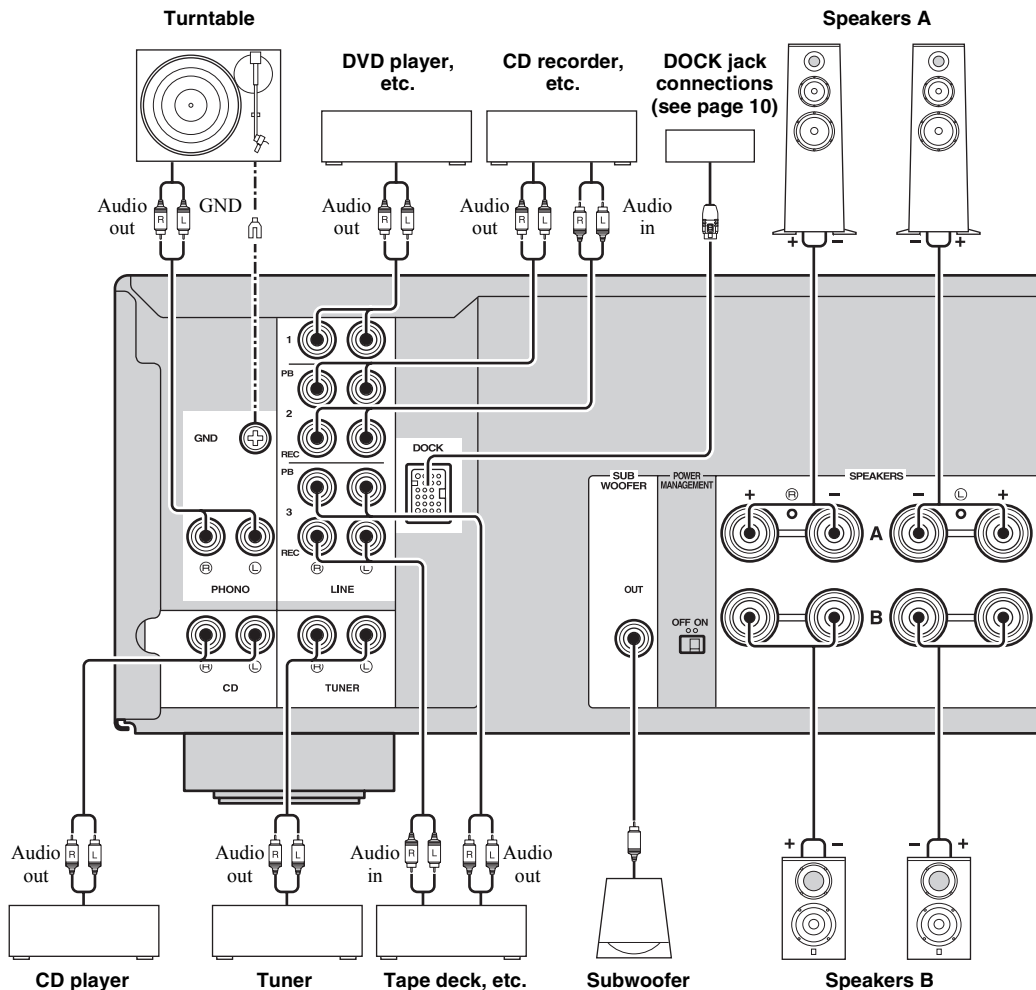

- The PHONO jacks are designed for connecting a turntable with an MM cartridge.
- Connect your turntable to the GND terminal to reduce noise in the signal. However, for some turntables, you may hear less noise without the GND connection.

CAUTION

- The IMPEDANCE SELECTOR switch must be set to the appropriate position before connecting speaker sets. See page 4 for details.
- Do not let the bare speaker wires touch each other or any metal part of this unit. This could damage this unit and/or the speakers.
- Do not connect this unit or other components to the main power until all connections between components are complete.

1 Remove approximately 10 mm (3/8 in) of insulation from the end of each speaker cable and twist the exposed wires of the cable together to prevent short circuits.

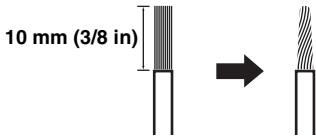

2 Connect the speaker cable.

- ① Unscrew the knob.
- ② Insert one bare wire into the hole in the side of each terminal.
- ③ Tighten the knob to secure the wire.

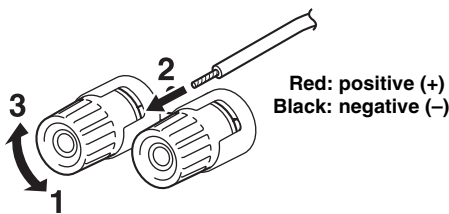

Connecting via banana plug (Except for Asia, U.K. and Europe models)

Tighten the knob and then insert the banana plug into the end of the corresponding terminal.

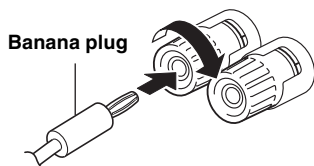

Bi-wire connection

Bi-wire connection separates the woofer from the combined midrange and tweeter section. A bi-wire compatible speaker has four binding post terminals. These two sets of terminals allow the speaker to be split into two independent sections. With these connections, the mid and high frequency drivers are connected to one set of terminals and the low frequency driver to another set of terminals.

This unit

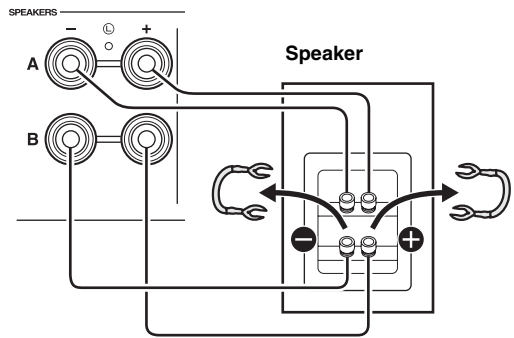

Connect the other speaker to the other set of terminals in the same way.

CAUTION

When making bi-wire connections, set the IMPEDANCE SELECTOR switch to HIGH or LOW depending on the impedance of your speakers:

6 Ω or higher: HIGH

4 Ω or higher: LOW

See page 4 for more information about the IMPEDANCE SELECTOR switch.

Note

When making bi-wire connections, remove the shorting bridges or cables on the speaker.



To use the bi-wire connections, switch the SPEAKERS selector to the A+B position.

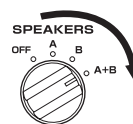

Connecting the power cable

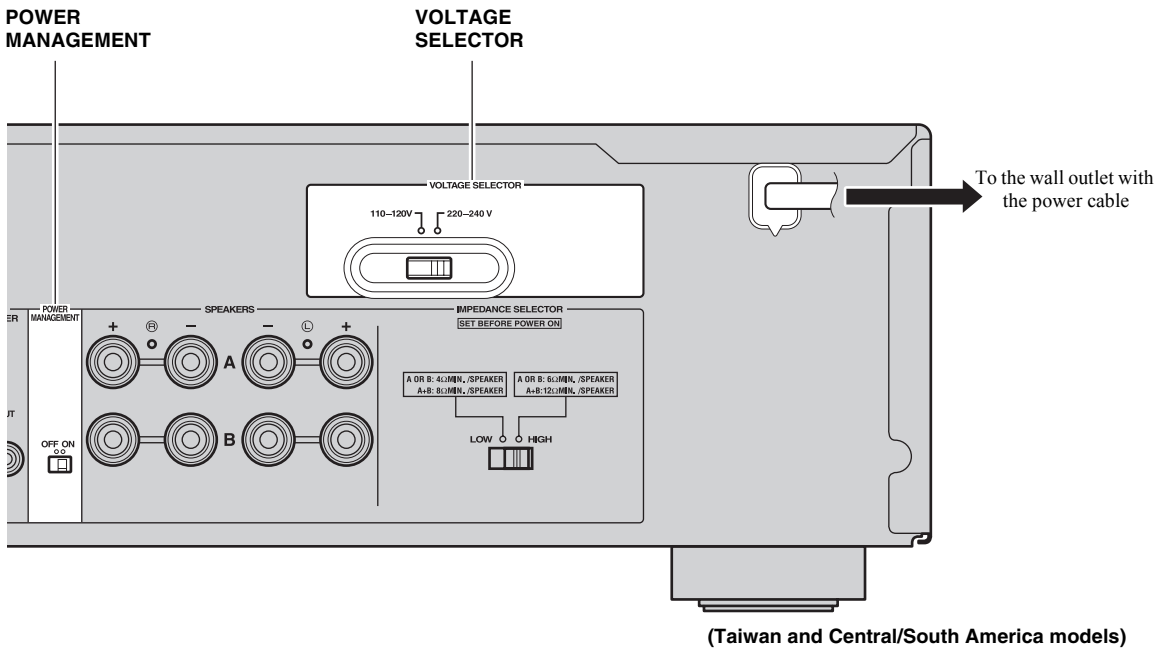

■ POWER MANAGEMENT switch

Enables or disables the automatic power down function. When the automatic power down function is enabled, this unit will automatically switch to standby mode if no operations are performed for 8 hours.

■ VOLTAGE SELECTOR switch (Taiwan and Central/South America models only)

The **VOLTAGE SELECTOR** switch on the rear panel of this unit must be set for your local main voltage **BEFORE** plugging the power cable into the wall outlet.

Improper setting of the **VOLTAGE SELECTOR** switch may cause damage to this unit and create a potential fire hazard.

Select the switch position (left or right) according to your local voltage using a straight slot screwdriver. Voltages are AC 110-120/220-240 V, 50/60 Hz.

■ Connecting the power cable

Plug the power cable into the wall outlet after all other connections are complete.

PLAYING AND RECORDING

Playing a source

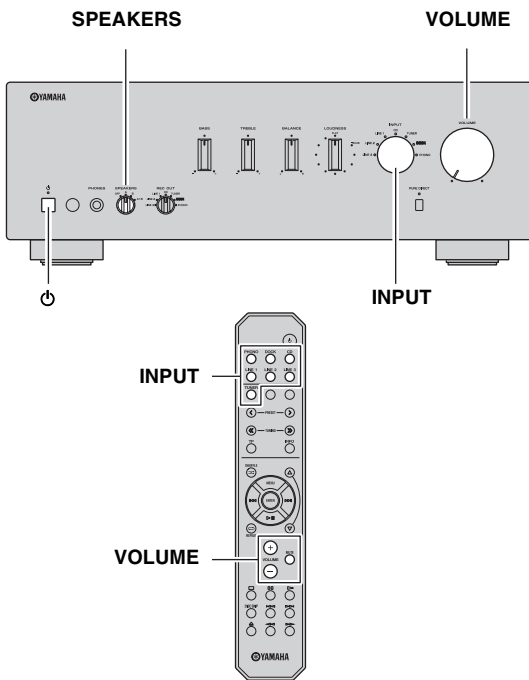

- 1 Rotate the **VOLUME** control on the front panel to the extreme counterclockwise position.
- 2 Press **⏻** switch on the front panel inward to turn on this unit.
- 3 Rotate the **INPUT** selector on the front panel (or press one of the **INPUT** selector buttons on the remote control) to select the input source you want to listen to.
The indicator for the selected input source lights up.
- 4 Rotate the **SPEAKERS** selector on the front panel to select **SPEAKERS A, B** or **A+B**.

Notes

- Set the **SPEAKERS** selector to the **A+B** position when two sets of speakers are connected using bi-wire connections, or when using two sets of speakers simultaneously (A and B).
- If you do not want sound to be heard from the speakers while listening with headphones, set the **SPEAKERS** selector to **OFF**.

- 5 Play the selected input source.

- 6 Rotate the **VOLUME** control on the front panel (or press **VOLUME +/-** buttons on the remote control) to adjust the sound output level.



You can adjust the tonal quality by using the **BASS**, **TREBLE**, **BALANCE** and **LOUDNESS** controls, or the **PURE DIRECT** switch on the front panel.

- 7 When finished listening, press **⏻** switch on the front panel outward to turn off this unit.



If **⏻** button on the remote control is pressed while the **⏻** switch on the front panel is in the on position, this unit enters standby mode. Press **⏻** button again to turn this unit on.

Adjusting the tonal quality

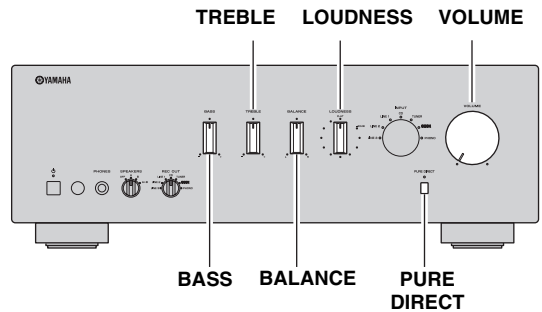

Using the PURE DIRECT switch

Routes input signals from your audio sources. As a result, the input signals bypass the **BASS**, **TREBLE**, **BALANCE** and **LOUDNESS** controls, thus eliminating any alterations to the audio signals to produce more direct and high-grade sound from all input sources.

Note

The **BASS**, **TREBLE**, **BALANCE** and **LOUDNESS** controls do not function while the **PURE DIRECT** switch is turned on.

■ Adjusting the BASS and TREBLE controls

The BASS and TREBLE controls adjust high and low frequency response.

The center position produces a flat response.

BASS

When you feel there is not enough bass (low frequency sound), rotate clockwise to boost. When you feel there is too much bass, rotate counterclockwise to suppress.

Control range: -10 dB to +10 dB (20 Hz)

TREBLE

When you feel there is not enough treble (high frequency sound), rotate clockwise to boost. When you feel there is too much treble, rotate counterclockwise to suppress.

Control range: -10 dB to +10 dB (20 kHz)

■ Adjusting the BALANCE control

The BALANCE control adjusts the sound output balance of the left and right speakers to compensate for sound imbalance caused by speaker locations or listening room conditions.

■ Adjusting the LOUDNESS control

Retain a full tonal range at any volume level, thus compensating for the human ears' loss of sensitivity to high and low-frequency ranges at low volume.

CAUTION

If the PURE DIRECT switch is turned on with the LOUDNESS control set at a certain level, the input signals bypass the LOUDNESS control, resulting in a sudden increase in the sound output level. To prevent your ears or the speakers from being damaged, be sure to press PURE DIRECT switch AFTER lowering the sound output level or AFTER checking that the LOUDNESS control is properly set.

1 Set the LOUDNESS control to the FLAT position.

2 Rotate the VOLUME control on the front panel (or press VOLUME +/- buttons on the remote control) to set the sound output level to the loudest listening level that you would listen to.

3 Rotate the LOUDNESS control until the desired volume is obtained.



After setting the LOUDNESS control, enjoy listening to music at your preferred volume level. If the effect of the LOUDNESS control setting is too strong or weak, readjust the LOUDNESS control.

Recording a source

Notes

- For the A-S500, audio signals are not output via the LINE 2 REC or LINE 3 REC output jacks when LINE 2 or LINE 3 is selected with the REC OUT selector.
- For the A-S300, audio signals are not output via the LINE 2 REC or LINE 3 REC output jacks when LINE 2 or LINE 3 is selected with the INPUT selector.
- This unit must be turned on in order to record.
- The VOLUME, BASS, TREBLE, BALANCE and LOUDNESS controls and the PURE DIRECT switch have no effect on the source being recorded.
- Check the copyright laws in your country before recording from records, CDs, radio, etc. Recording copyright-protected material may infringe on copyright laws.

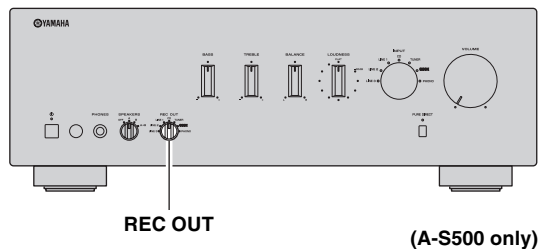

1 Rotate the REC OUT selector on the front panel to select the source you want to record (A-S500 only).

Note

When using the A-S300, the current input source will be recorded.

2 Play the source and begin recording using the recording device connected to the REC output jacks (LINE 2 and/or LINE 3) on the rear panel. See page 5.



A-S500 only: While recording, you can select another input source using the INPUT selector or the remote control and listen to another input source without affecting recording.

PLAYING BACK TUNES FROM YOUR iPhone/iPod

Once you have connected an optional Yamaha Universal Dock for iPod or Wireless System for iPod to the DOCK jack on the rear panel of this unit, you can enjoy playback of your iPhone/iPod using the remote control supplied with this unit.

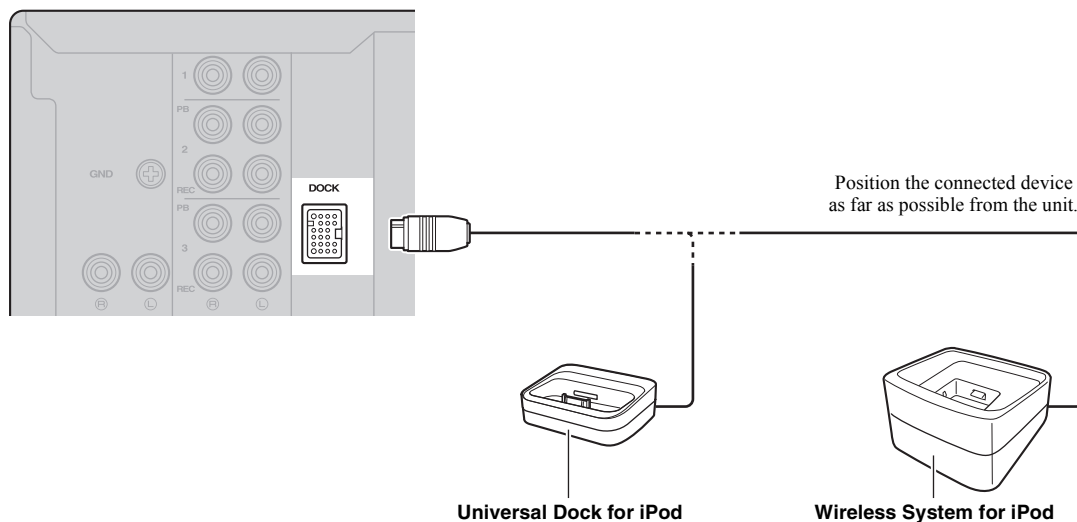

	Universal Dock for iPod	Wireless System for iPod
Model (As of July 2010)	<ul style="list-style-type: none"> • YDS-12 • YDS-11 • YDS-10 	YID-W10
Operated by	<ul style="list-style-type: none"> • Remote control • iPhone/iPod connected to the dock 	<ul style="list-style-type: none"> • iPhone/iPod connected to the YID-W10 transmitter • Remote control
Supported iPhone/iPod (As of July 2010)	<ul style="list-style-type: none"> • iPod touch • iPod (4th Gen/5th Gen/classic) • iPod nano • iPod mini • iPhone • iPhone 3G/3GS 	<ul style="list-style-type: none"> • iPod touch • iPod (5th Gen/classic) • iPod nano • iPhone • iPhone 3G/3GS
Remarks	<ul style="list-style-type: none"> • iPhone/iPod charging also supported. • The YDS-10/YDS-11 does not support iPhone connection. 	iPhone/iPod charging also supported.

CAUTION

To prevent accidents, unplug the power cable of this unit before connecting a Universal Dock for iPod or a Wireless System for iPod.

Note

If the iPhone connected to the YID-W10 receives a call while this unit is in standby mode, the unit turns on automatically and the ringtone is heard through this unit. If you do not want this unit to turn on when a call is received, set the iPhone to silent mode.

Using a Universal Dock for iPod

After setting your iPhone/iPod in your dock, rotate the INPUT selector on the front panel (or press DOCK button on the remote control) to select DOCK as the input source to play your iPhone/iPod.

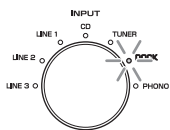

Front panel

or

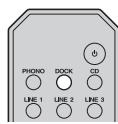

Remote control

While viewing the information displayed on your iPhone/iPod, use the following remote control buttons to operate (playback, pause, skip, etc.) your iPhone/iPod.

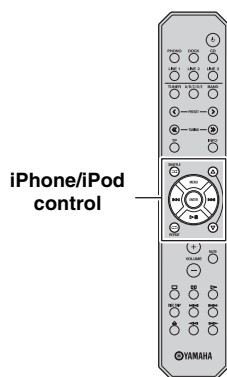

Remote control	Operation
MENU	Displays the menu.
ENTER	<ul style="list-style-type: none"> • If an item is selected: Confirms the item and displays the next screen. • If a song is selected: Plays the selected song.
△	Scroll up.
▽	Scroll down.
⏸	<ul style="list-style-type: none"> • If a song is playing: Pauses the song. • If a song is paused: Plays the song.
⏭	<ul style="list-style-type: none"> • If a song is playing or paused: Skips to the beginning of the next song. • If pressed and held: Searches forward.
⏮	<ul style="list-style-type: none"> • If a song is playing or paused: Skips to the beginning of the current song. • Pressing repeatedly skips one song backwards with each press. • If pressed and held: Searches backward.
⏵	Switches between shuffle modes (Off → Songs → Albums → Off).
⏪	Switches between repeat modes (Off → One → All → Off).

Note

Some shuffle modes and repeat modes may not be available depending on the model or the software version of your iPhone/iPod.



When this unit is turned on or is in standby mode, your iPhone/iPod can be charged automatically if it is connected to a Universal Dock for iPod. If an iPhone/iPod is charged while this unit is in standby mode, the POWER on indicator lights up brightly.

Using a Wireless System for iPod

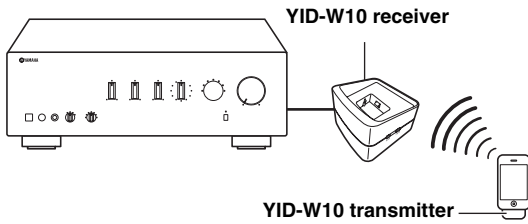

■ Establishing a wireless connection

Once the iPhone/iPod is connected to the transmitter and playback begins, it takes about 5 seconds for audio to be heard. During this time the wireless connection between the transmitter and receiver is established.

The status of the wireless connection between the transmitter and receiver is indicated by the respective status indicator.

Status of connection	Transmitter indicator	Receiver indicator
No connection	Off	Off
Confirming connection	Green, flashing	Blue, flashing
Connected	Green, lit	Blue, lit

■ Controlling this unit with your iPhone/iPod

- When playback begins on an iPhone/iPod that is connected to a transmitter, and if the transmitter is within range of the receiver, this unit performs as follows:
 - If this unit is already turned on when playback begins: The input source switches to DOCK.
 - If this unit is in standby mode when playback begins: This unit turns on and the input source switches to DOCK.
- Adjusting the volume on the iPhone/iPod also adjusts the volume of this unit. Note that the iPhone/iPod can only be used to increase this unit's volume to a certain level; to increase it further, adjust the volume using this unit's VOLUME control or the remote control.
- In the following situations, the wireless connection between the transmitter and receiver is disconnected. After 30 seconds this unit automatically enters standby mode.
 - The iPhone/iPod is not operated for about 30-120 seconds after the playback is paused.
 - The sleep timer of the iPhone/iPod is activated.
 - The iPhone/iPod is disconnected from the transmitter.
 - The iPhone/iPod battery level decreases to a level where it cannot provide enough power to the transmitter.
 - The transmitter is moved outside of the wireless communication range of the receiver.

- Communication between the transmitter and receiver becomes disrupted due to interference from other wireless LAN devices, cordless telephones, microwave ovens, etc.



- You can use the remote control to control the iPhone/iPod. For more information, see page 11.
- When this unit is turned on or is in standby mode, your iPhone/iPod can be charged automatically if the transmitter connected to your iPhone/iPod is stationed to the receiver. If an iPhone/iPod is charged while this unit is in standby mode, the POWER on indicator lights up brightly.
- Refer to the operating instructions of the YID-W10 for more information.

TROUBLESHOOTING

Refer to the chart below if this unit does not function properly. If the problem you are experiencing is not listed below or if the instructions below do not help, turn off this unit, disconnect the power cable, and contact the nearest authorized Yamaha dealer or service center.

■ General

Problems	Possible Causes	Solutions	Refer to page
This unit is not turned on. The POWER on indicator also does not light up.	The power cable is not connected.	Connect the power cable firmly.	7
	The \odot button is pressed on the remote control while this unit is turned off.	Press \odot switch on the front panel to ON.	2
	There is a problem with the internal circuitries of this unit.	Disconnect the power cable and contact the nearest authorized Yamaha dealer or service center. If an unusual odor or noise is generated from the unit, do not turn on the power, disconnect the power cable, and contact a service center for repair.	—
This unit turns off suddenly and the POWER on indicator blinks. This unit is turned off after several seconds of turning on, and the POWER on indicator blinks.	The speaker wires are touching each other or shorting out against the rear panel.	Connect the speaker cables properly and press the \odot switch again. The INPUT indicators blink and the volume is decreased automatically. After the volume has decreased to the lowest setting, the INPUT indicators stop flashing, the INPUT indicator of the last input source selected lights up, and the unit may be used again. Confirm normal sound output from speakers by increasing the volume gradually, then operate this unit normally.	6
	The speaker is malfunctioning.	Replace the speaker set and press the \odot switch again. The INPUT indicators blink and the volume is decreased automatically. After the volume has decreased to the lowest setting, the INPUT indicators stop flashing, the INPUT indicator of the last input source selected lights up, and the unit may be used again. Confirm normal sound output from speakers by increasing the volume gradually, then operate this unit normally.	—
	The protection circuitry has been activated because of excessive input or excessive volume level.	Rotate the VOLUME control on the front panel to decrease the volume level and then turn the power on again.	—
	The protection circuitry has been activated due to excessive internal temperature.	Allow about 30 minutes for the temperature inside this unit to decrease, rotate the VOLUME control on the front panel to lower the volume and then turn the power on again. Set the unit in a place where heat can readily dissipate from the unit.	—
	The IMPEDANCE SELECTOR switch is not fully slid to either position.	Turn the power off and slide the IMPEDANCE SELECTOR switch all the way to the correct position.	4
	The IMPEDANCE SELECTOR switch is not set to the correct position.	Set the IMPEDANCE SELECTOR switch to the position that corresponds to the impedance of your speakers.	4
	This unit has been exposed to a strong external electric shock (such as lightning or strong static electricity).	Set this unit to standby mode, disconnect the power cable, plug it back in after 30 seconds, then use the unit normally.	—
	There is a problem with the internal circuitries of this unit.	Disconnect the power cable and contact the nearest authorized Yamaha dealer or service center. If an unusual odor or noise is generated from the unit, do not turn on the power, disconnect the power cable, and contact a service center for repair.	—

Problems	Possible Causes	Solutions	Refer to page
No sound.	Sound is muted.	Press MUTE button on the remote control or rotate the VOLUME control.	3
	Incorrect cable connections.	Connect the stereo cable for audio units and the speaker wires properly. If the problem persists, the cables may be defective.	5
	Playback has been stopped on the connected component.	Turn the component on and start playback.	8
	No appropriate input source has been selected.	Select an appropriate input source with the INPUT selector on the front panel (or one of the INPUT selector buttons on the remote control).	8
	The SPEAKERS selector is not set properly.	Set the corresponding SPEAKERS selector to A, B or A+B position.	8
The sound suddenly goes off.	The protection circuitry has been activated because of a short circuit, etc.	Check that the IMPEDANCE SELECTOR setting is correct.	4
		Check that the speaker wires are not touching each other or shorting out against the rear panel of this unit, and then turn this unit on again.	5
	This unit has become too hot.	Reconsider the location where this unit is installed. Make sure the openings on the top panel are not blocked.	—
	The automatic power down function has turned this unit off.	Confirm that there are no other issues causing this problem, and then turn this unit on again.	7
Only the speaker on one side can be heard.	Incorrect cable connections.	Connect the cables properly. If the problem persists, the cables may be defective.	5
	Incorrect setting for the BALANCE control.	Set the BALANCE control to the appropriate position.	9
There is a lack of bass and no ambience.	The + and – wires are connected in reverse at the amplifier or the speakers.	Connect the speaker wires to the correct + and – phase.	6
A “humming” sound can be heard.	Incorrect cable connections.	Connect the audio plugs firmly. If the problem persists, the cables may be defective.	5
	No connection from the turntable to the GND terminal.	Make the GND connection between the turntable and this unit.	5
The volume level is low while playing a record.	The turntable is connected to the jacks other than the PHONO jacks.	Connect the turntable to the PHONO jacks.	5
	The record is being played on a turntable with an MC cartridge.	Use a turntable equipped with an MM cartridge.	—
The volume level cannot be increased, or the sound is distorted.	The component connected to the LINE 2 REC or LINE 3 REC jacks of this unit is turned off.	Turn on the power of the component.	—
The sound is degraded when listening with the headphones connected to the CD player or the tape deck connected to this unit.	This unit is turned off or is in standby mode.	Turn this unit on.	8
The sound level is low.	Sound is muted.	Press MUTE button on the remote control or rotate the VOLUME control.	3
	The loudness control function is operating.	Turn down the volume, set the LOUDNESS control to the FLAT position, and then adjust the volume again.	9

Problems	Possible Causes	Solutions	Refer to page
Using the BASS, TREBLE, BALANCE and LOUDNESS controls does not affect the tonal quality.	The PURE DIRECT switch is turned on.	The PURE DIRECT switch must be turned off to use those controls.	8

■ Universal Dock for iPod and Wireless System for iPod

Problems	Possible Causes	Solutions	Refer to page
No sound. You cannot operate the iPhone/iPod.	There is a problem with the signal path from your iPhone/iPod to the unit.	Turn off the unit and reconnect the Universal Dock for iPod or the Wireless System for iPod to the DOCK jack of the unit.	10
		Remove your iPhone/iPod from the Universal Dock for iPod or the Wireless System for iPod and then place it back in the dock.	10
	The iPhone/iPod being used is not supported by the unit.	Connect an iPhone/iPod supported by the unit.	10
When using a Wireless System for iPod: Sound frequently cuts out. Noise is heard.	The wireless connection is poor.	Place the YID-W10 receiver as far away from this unit as possible.	10
When using the Universal Dock for iPod: Your iPhone/iPod is not being charged even though it is connected to the Universal Dock for iPod.	This unit is not turned on.	Turn on this unit or set it to standby mode.	2
	The iPhone/iPod is not connected securely.	Connect the iPhone/iPod securely to the Universal Dock for iPod.	10
When using the Wireless System for iPod: Your iPhone/iPod is not being charged even though the YID-W10 transmitter connected to your iPhone/iPod is stationed in the YID-W10 receiver.	This unit is not turned on.	Turn on this unit or set it to standby mode.	2
	The YID-W10 transmitter is not stationed securely in the YID-W10 receiver.	Station the YID-W10 transmitter connected to your iPhone/iPod securely in the YID-W10 receiver.	10

■ Remote control

Problems	Possible Causes	Solutions	Refer to page
The remote control does not work nor function properly.	The remote control is too far away or tilted too much.	The remote control will function within a maximum range of 6 m (20 ft) and no more than 30 degrees off-axis from the front panel.	3
	Direct sunlight or lighting (from an inverter type of fluorescent lamp, etc.) is striking the remote control sensor of this unit.	Reposition this unit or lighting.	—
	The batteries are weak.	Replace all batteries.	3

■ Notes on batteries

- Change both batteries when the operation range of the remote control decreases.
- Remove the batteries if the remote control is not to be used for an extended period of time.
- Do not use old batteries together with new ones.
- Do not use different types of batteries (such as alkaline and manganese batteries) together. Read the packaging carefully as these different types of batteries may have the same shape and color.
- If the batteries have leaked, dispose of them immediately. Avoid touching the leaked material or letting it come into contact with clothing, etc. Clean the battery compartment thoroughly before installing new batteries.
- Do not throw away batteries with general house waste; dispose of them correctly in accordance with your local regulations.

■ Handling the remote control

- Do not spill water or other liquids on the remote control.
- Do not drop the remote control.
- Do not leave or store the remote control in the following types of conditions:
 - high humidity, such as near a bath
 - high temperature, such as near a heater or a stove
 - extremely low temperatures
 - dusty places
- Do not expose the remote control sensor to strong lighting, in particular, an inverter type fluorescent lamp; otherwise, the remote control may not work properly. If necessary, position the unit away from direct lighting.

SPECIFICATIONS

AUDIO SECTION

- Minimum RMS output power
(8 Ω, 20 Hz to 20 kHz, 0.019% THD)
[A-S500] 85 W + 85 W
[A-S300] 60 W + 60 W
(6 Ω, 20 Hz to 20 kHz, 0.038% THD) [Except for Asia model]
[A-S500] 100 W + 100 W
[A-S300] 70 W + 70 W
- Dynamic power per channel (IHF) (8/6/4/2 Ω)
[A-S500] 130/150/185/220 W
[A-S300] 100/120/140/150 W
- Maximum power per channel [U.K. and Europe models only]
(1 kHz, 0.7% THD, 4 Ω)
[A-S500] 120 W
[A-S300] 95 W
- IEC power [U.K. and Europe models only]
(1 kHz, 0.019% THD, 8 Ω)
[A-S500] 100 W
[A-S300] 75 W
- Power band width
[A-S500] (0.06% THD, 42.5 W, 8 Ω) 10 Hz to 50 kHz
[A-S300] (0.06% THD, 30 W, 8 Ω) 10 Hz to 50 kHz
- Damping factor (SPEAKERS A)
1 kHz, 8 Ω 240 or more
- Maximum effective output power (JEITA)
(1kHz, 10% THD, 8 Ω) [Asia, China, Taiwan and Central/South America models only]
[A-S500] 130 W
[A-S300] 100 W
(1kHz, 10% THD, 6 Ω) [China, Taiwan and Central/South America models only]
[A-S500] 150 W
[A-S300] 110 W
- Input sensitivity/Input impedance
PHONO (MM) 3.0 mV/47 kΩ
CD, etc. 200 mV/47 kΩ
- Maximum input signal
PHONO (MM) (1 kHz, 0.003% THD) 60 mV or more
CD, etc. (1 kHz, 0.5% THD) 2.2 V or more
- Output level/Output impedance
REC 200 mV/1.0 kΩ or less
- PHONES jack rated output/Impedance
CD, etc. (Input 1 kHz, 200 mV, 8 Ω)
[A-S500] 430 mV/470 Ω
[A-S300] 360 mV/470 Ω
- Frequency response
CD, etc. (20 Hz to 20 kHz) 0 ± 0.5 dB
CD, etc. PURE DIRECT on (10 Hz to 100 kHz) 0 ± 1.0 dB
- RIAA equalization deviation
PHONO (MM) ± 0.5 dB
- Total harmonic distortion
PHONO (MM) to REC (20 Hz to 20 kHz, 3 V) 0.025% or less
CD, etc. to SPEAKERS
[A-S500] (20 Hz to 20 kHz, 42.5 W, 8 Ω) 0.015% or less
[A-S300] (20 Hz to 20 kHz, 30 W, 8 Ω) 0.015% or less
- Signal to noise ratio (IHF-A network)
PHONO (MM) (5 mV input shorted) 88 dB or more
CD, etc. PURE DIRECT on
(200 mV input shorted) 100 dB or more
- Residual noise (IHF-A network) 30 μV

- Channel separation
CD, etc. (5.1 kΩ input shorted, 1/10 kHz) 65/50 dB or more
- Tone control characteristics
BASS
Boost/Cut (50 Hz) ±10 dB
Turnover frequency 350 Hz
TREBLE
Boost/Cut (20 kHz) ±10 dB
Turnover frequency 3.5 kHz
- Continuous loudness control
Attenuation (1 kHz) -30 dB
- Gain tracking error (0 to -99 dB) 0.5 dB or less

GENERAL

- Power supply
[U.S.A. and Canada models] AC 120 V, 60 Hz
[Asia model] AC 220-240 V, 50/60 Hz
[Taiwan and Central/South America models]
..... AC 110-120/220-240 V, 50/60 Hz
[China model] AC 220 V, 50 Hz
[Australia model] AC 240 V, 50 Hz
[U.K., Europe and Russia models] AC 230 V, 50 Hz
- Power consumption
[A-S500]
[U.S.A. and Canada models] 240 W, 330 VA
[Asia model] 220 W
[Other models] 240 W
[A-S300] 190 W
- Standby power consumption 0.5 W or less
- YID-W10 standby power consumption
(YID-W10 connect) 1.2 W or less
- iPod charge power consumption
[A-S500] 35 W or less
[A-S300] 25 W or less
- Maximum power consumption [Taiwan and Central/South America models only]
(6 Ω, 1 kHz, 10% THD)
[A-S500] 510 W
[A-S300] 400 W
- Dimensions (W × H × D) 435 × 151 × 387 mm
(17-1/8" × 6" × 15-1/4")
- Weight
[A-S500] 10.3 kg (22.7 lbs)
[A-S300] 9.0 kg (19.8 lbs)

Specifications are subject to change without notice.

iPhone, iPod

iPhone, iPod, iPod classic, iPod nano and iPod touch are trademarks of Apple Inc., registered in the U.S. and other countries.

Important Notice: Guarantee Information for customers in EEA* and Switzerland**English**

For detailed guarantee information about this Yamaha product, and Pan-EEA* and Switzerland warranty service, please either visit the website address below (Printable file is available at our website) or contact the Yamaha representative office for your country. * EEA: European Economic Area

<http://europe.yamaha.com/warranty/>

Information for Users on Collection and Disposal of Old Equipment and Used Batteries



These symbols on the products, packaging, and/or accompanying documents mean that used electrical and electronic products and batteries should not be mixed with general household waste.

For proper treatment, recovery and recycling of old products and used batteries, please take them to applicable collection points, in accordance with your national legislation and the Directives 2002/96/EC and 2006/66/EC.



By disposing of these products and batteries correctly, you will help to save valuable resources and prevent any potential negative effects on human health and the environment which could otherwise arise from inappropriate waste handling.



For more information about collection and recycling of old products and batteries, please contact your local municipality, your waste disposal service or the point of sale where you purchased the items.

[Information on Disposal in other Countries outside the European Union]

These symbols are only valid in the European Union. If you wish to discard these items, please contact your local authorities or dealer and ask for the correct method of disposal.



Note for the battery symbol (bottom two symbol examples):

This symbol might be used in combination with a chemical symbol. In this case it complies with the requirement set by the Directive for the chemical involved.

Pb

